

DOI: 10.5604/01.3001.0010.4599

## NEEDLE DETECTOR OF X-RAY AND GAMMA RADIATION

Grzegorz Domański, Roman Szabatin, Piotr Brzeski, Bogumil Konarzewski

Warsaw University of Technology, The Institute of Radioelectronics and Multimedia Technology

**Abstract.** The article presents the developed structure of the novel needle proportional gas detector (NPC – Needle Proportional Counter) used for the detection of X-rays and gamma rays. The advantage of the detector is its simple mechanical construction and the possibility of detection of incident radiation in a direction parallel to the needle. The measured energy spectrum of the isotope Fe-55 by means of the developed detector is presented.

**Keywords:** gas detector with electron multiplication, x-ray detector, gamma radiation

### DETEKTOR IGŁOWY PROMIENIOWANIA X I GAMMA

**Streszczenie.** Artykuł przedstawia opracowaną konstrukcję nowego typu gazowego detektora igłowego, służącego do detekcji promieniowania X i gamma. Zaletą detektora jest jego prosta konstrukcja mechaniczna i możliwość detekcji promieniowania w kierunku równoległym do igły. Zmierzono widmo energetyczne izotopu Fe-55 opracowanym detektorem.

**Słowa kluczowe:** Detektor z gazowym powielaniem elektronów, detektor promieniowania X, promieniowanie gamma

### Introduction

Gas detectors history dates back to the first half of the twentieth century, when in 1908 H. Geiger and E. Rutherford developed a proportional counter [7]. The further development led to a Geiger-Müller counter by H. Geiger and W. Müller in 1928. [3]. In the second half of the twentieth century G. Charpak developed the Multiwire Proportional Chamber [2] (in 1968). In 1988, A. Oed proposed Micro-Strip Gas Chamber [6], and in 1997, F. Sauli introduced Gas Electron Multiplier [8]. The general concept of gas detector is shown in the Figure 1. Gas detectors of ionizing radiation are used among other things in medicine, astronomy [1], and high energy physics experiments [4, 5].

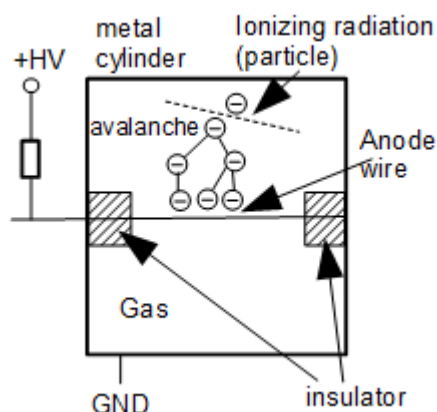

Fig. 1. General concept of a gas detector

The construction of the detector is shown schematically in the Figure 1. Ionizing radiation, passing through the matter, it loses its energy, among other things on its ionization. X-ray and gamma ray is electromagnetic radiation that can ionizing matter indirectly. First quantum of electromagnetic radiation can interact with an atom in photoelectric, Compton or creation of pairs effect [5]. As a result of this interaction arises, one or more charged particles that moving in a material medium, ionize them. The gas detectors have an active volume of the filling gas in which ionization occurs. Metal electrodes produce electric field and separate electrical charges that drift toward the electrodes. Radiation produced by the original electric charge can be amplified if close to one of the electrodes - the anode - there is a sufficiently strong electric field [8]. One type of gas detectors are proportional counters, which have anode metal wire of a small diameter. Formed during a single gamma quantum detection electric charge in the detector is proportional to the quantum energy. One of the problems is low detection efficiency of X-rays or gamma rays in gas detectors. This article presents a new type of gas detector, wherein a metal needle plays role of an anode, while the radiation

is incident in a direction parallel to the needle. The anode is supported on one side only, which simplifies the construction of such a detector.

### 1. Methods

The concept of the needle detector is as follows: a metal acupuncture needle having a diameter of less than 0.2 mm is soldered to the PCB. The needle is connected to a high positive potential, while the detector is placed in a metal housing, which is at zero potential. Electrostatic field in gas detectors is described by Laplace equation

$$\nabla^2 \Phi = 0, \quad (1)$$

where  $\Phi$  – electric potential. Electric field  $E$  is given by

$$E = -\nabla \Phi \quad (2)$$

In cylindrical coordinates with axial symmetry the Laplace equation takes the form

$$\frac{1}{r} \frac{\partial}{\partial r} \left( r \frac{\partial \Phi}{\partial r} \right) = 0, \quad (3)$$

where  $r$  – radial distance from the axis of symmetry. For a detector with an anode made of a wire having a radius  $R_A$ , placed in the axis of symmetry of the cylinder of radius  $R_C$ , the potential is given by the following formula electric field strength is given by the formula

$$\Phi(r) = \frac{U}{\ln(R_C / R_A)} \ln\left(\frac{r}{R_A}\right), \quad (4)$$

where  $U$  - the voltage between the anode and the cathode,  $r$  - the distance from the axis of symmetry of the anode.

The electric field strength is given by the formula

$$E = \frac{U}{r \ln(R_C / R_A)}, \quad (5)$$

Near the anode  $r = R_A$  and field strength is equal to

$$E = \frac{U}{R_A \ln(R_C / R_A)}. \quad (6)$$

The capacitance per unit length of tube is given by

$$C = \frac{2\pi\epsilon_0}{\ln(R_C / R_A)}, \quad (7)$$

where  $\epsilon_0$  – vacuum permittivity.

In spherical coordinates with spherical symmetry the Laplace equation takes the form

$$\frac{1}{r^2} \frac{\partial}{\partial r} \left( r^2 \frac{\partial \Phi}{\partial r} \right) = 0, \quad (8)$$

If we approximate the shape of the tip of the needle by the sphere of radius  $R_S$  and the cathode by the sphere of radius  $R_X$  then the potential is given by

$$\Phi = U \left( \frac{1}{1 - \frac{R_S}{R_X}} - \frac{1}{\frac{1}{R_S} - \frac{1}{R_X}} \right) \quad (9)$$

The electric field is given by

$$E = \frac{U}{\left( \frac{1}{R_S} - \frac{1}{R_X} \right) r^2} \quad (10)$$

Near the rounded end of the needle electric field strength is

$$E = \frac{U}{R_S \left( 1 - \frac{R_S}{R_X} \right)} \quad (11)$$

and may be much larger than the intensity at the surface of the anode wire as the conditions  $R_S < R_A$ ,  $R_S \ll R_X$  are usually fulfilled, and additionally in formula (5) the factor  $\ln(R_C / R_A)$  reduces at least several times the value of the field strength.

The interior of the detector is filled with noble gas (helium, neon, argon, xenon). Ionizing particle, flowing into the detector produces original electric charge - electrons and positive ions. Electrons are attracted to the positively charged needle. Ionization and avalanche multiplication of electric charge occurs in strong electric field. The needle serves as the anode and the outer casing serves as the cathode.

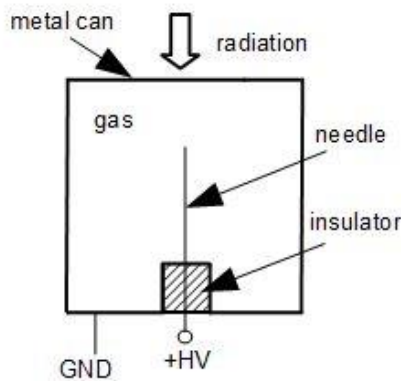

Fig. 2. Scheme of the needle detector

The construction of the detector is shown schematically in Figure 2. The geometry of the needle tip is shown in the Figure 3.

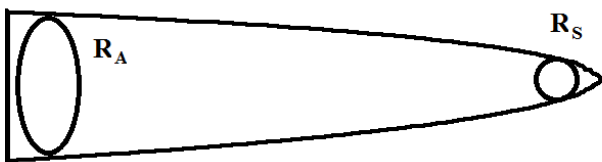

Fig. 3. The geometry of the needle tip

The actual shape of the needle cylinder deviates from the rounded end. Calculation of field distribution requires the use of one of the numerical methods, for example Finite Differences, Finite Element Method or Boundary Element Method. The photo of the developed device is shown in the Figure 4. One can see the metal housing and the anode in the middle of it. The anode is made of a steel acupuncture needle coated with a layer of gold having a diameter of 0.16 mm.



Fig. 4. Photo of the developed device

In order to verify the correctness of the concept of building a new type of gamma and x-ray detector based on acupuncture needle the simulation of the electric field distribution has been carried out by means of the program COMSOL. An electric potential distribution in a plane perpendicular to the needle is shown in the Figure 5.

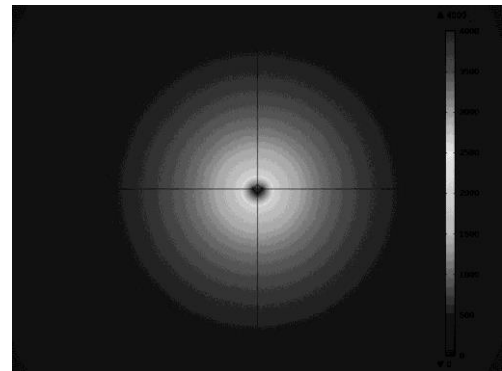

Fig. 5. An electric potential distribution in a plane perpendicular to the needle

An axial symmetry in potential distribution is visible. An electric potential distribution in a plane parallel to the needle is shown in the Figure 6. The strongest electric field is near the tip of the needle.

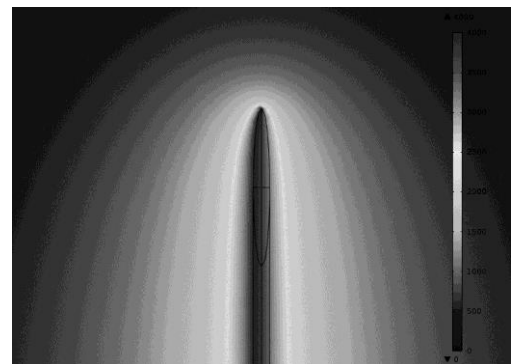

Fig. 6. An electric potential distribution in a plane parallel to the needle

An electric potential distribution in a plane perpendicular to sixteen needles is shown in the Figure 7.

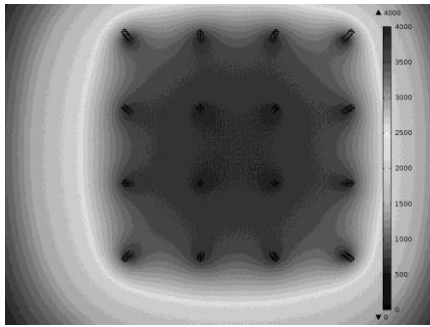

Fig. 7. An electric potential distribution in a plane perpendicular to sixteen needles

An electric potential distribution in a plane parallel to sixteen needles is shown in the Figure 8.

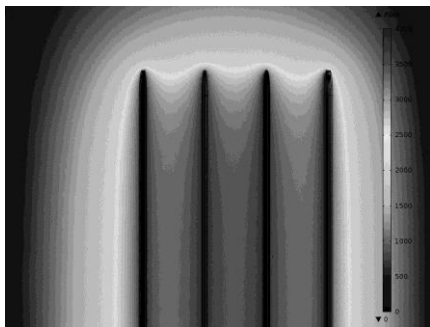

Fig. 8. An electric potential distribution in a plane parallel to sixteen needles

## 2. Results

Designed needle detector has been connected to a high voltage power supply with a value of 1440 V, generated by the power supply type HRS-41 produced by POLON. As a radioactive source isotope Fe-55 that emits X-rays with an energy of 5.9 keV has been used. Radiation beam has been collimated, so it has hit near the tip of the needle. The interior was filled with a detector gas composition of 90% Ar + 10% CH<sub>4</sub>. Schematic of the measuring system is shown in the Figure 9. As a preamplifier the CR-112 chip produced by Cremat has been used. The signal from the preamplifier has been gained by the linear amplifier type 1101 produced by POLON. The gain value has been 320V/V.

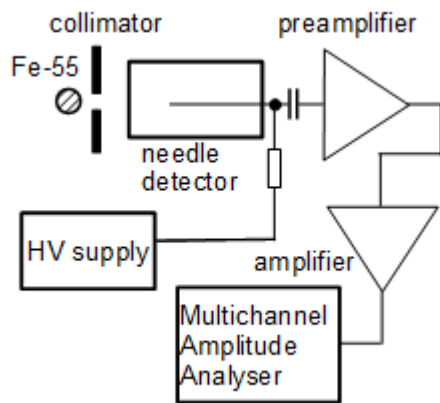

Fig. 9. Diagram of the measuring system of the needle detector

Photo of the proportional counter used as the reference detector is shown in the Figure 10. Pulse amplitude spectrum has been measured by multichannel pulse amplitude analyzer TUKAN 8K produced by IPJ. The spectrum of X-rays coming from the

isotope Fe-55 measured by the reference detector is shown in the Figure 11. The multichannel amplitude analyzer has worked in the mode of 1024 channels. The input voltage range has been 0..+10V.

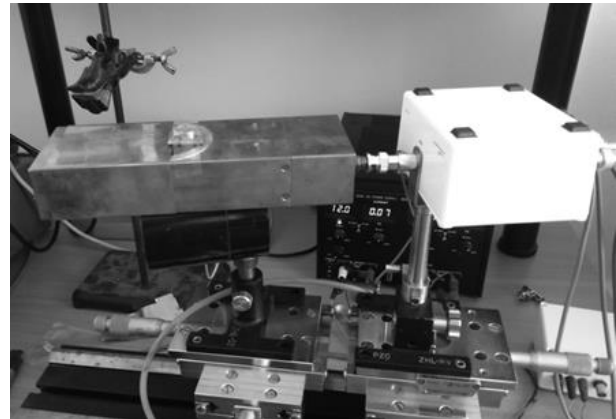

Fig. 10. Photo of the proportional counter used as the reference detector

The spectrum of X-rays coming from the isotope Fe-55 measured by the developed detector is shown in the Figure 12. The clear peak is visible in the spectrum, dating from the photoelectric effect. Energy resolution was approximately 30%.

Fe-55 spectrum measured by Proportional Counter

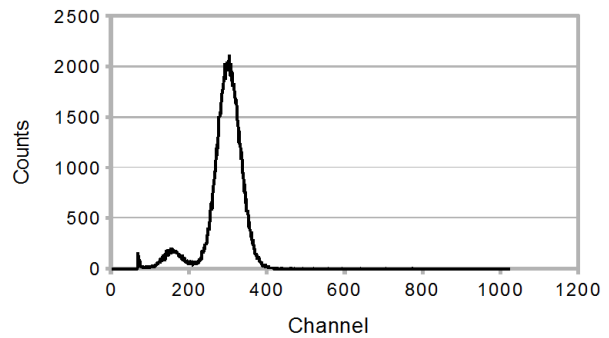

Fig. 11. The spectrum of X-rays coming from the isotope Fe-55 measured by the reference detector – proportional counter

The obtained spectrum is consistent with the reference one.

Fe-55 spectrum measured by developed needle detector

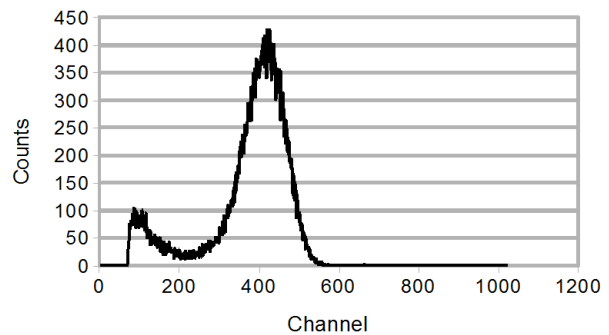

Fig. 12. The spectrum of X-rays coming from the isotope Fe-55 measured by the developed detector

Pulse amplitude spectrum measurements have confirmed the developed device ability to detect x-ray and gamma radiation.

### 3. Conclusions

The advantage of the detector is its simple mechanical construction. Acupuncture needles produced on a mass scale are relatively cheap and have a very good quality parameters. They are also used not only in medicine [9]. Due to the treatment a lack of support on the one side it is possible to detect incident radiation in a direction parallel to the needle. As a result, the thickness of the gas layer at which an x-ray detection occurs can be large, which increases the efficiency of the detection. It is also possible to construct a positional detector MN-PC (Multi-Needle Proportional Chamber) analogous to the multi-wire proportional chamber (MWPC) [2].

### References

- [1] Borkhari A.F., Yasserian K.: Influence of the hot filament on the electrical breakdown characteristics in the presence of Ar/N<sub>2</sub>. *Journal of Theoretical and Applied Physics*, 7/2013.
- [2] Charpak G., Bouclier R., Bressani T., Favier J., Zupančič Č.: The use of multiwire proportional counters to select and localize charged particles. *Nuclear Instruments and Methods*, 62(3)/1968, 262–268.
- [3] Geiger H., Müller W.: Das Elektronenzählrohr, *Physikalische Zeitschrift*, 29/1928, 839–841.
- [4] Ketzer B., Bachmann S., Cape M., Deutel M., Friedrich J., Kapple S., Konorov I., Placci A., Reisinger K., Ropelewski L., Shekhtman L., Sauli F.: GEM detectors for COMPASS. *IEEE Transaction on Nuclear Science*, 48/2001, 1065–1069.
- [5] Knoll Glenn F.: *Radiation Detection and Measurement*. John Wiley and Sons, New York, 1999.
- [6] Oed A.: Position-sensitive detector with microstrip anode for electron multiplication with gases. *Nuclear Instruments and Methods*, A263/1988, 351–359.
- [7] Rutherford E., Geiger H.: An electrical method of counting the number of alpha particles from radioactive substances. *Proceedings of the Royal Society A81/1908*, 141–161.
- [8] Sauli F.: GEM A new concept for electron amplification in gas detectors. *Nuclear Instruments and Methods in Physics Research*, 386/1997, 531–534.
- [9] Yun Z.L., Bin C., Yiming Z.: Fabrication of anti-reflective micro-structure at terahertz frequency by using Chinese acupuncture needles. *Optics Letters*, 2015, 2917–2920.

**Ph.D. Eng. Grzegorz Domański**  
e-mail: G.Domanski@ire.pw.edu.pl

M.Sc. ('94), Ph.D. ('01); nuclear and medical electronics; Assistant Professor, Nuclear and Medical Electronics Division, Institute of Radioelectronics and Multimedia Technology, Faculty of Electronics and Information Technology, Warsaw University of Technology. Faculty Coordinator of Radiological Protection ('02-); Tutorial assistance of Biomedical and Nuclear Engineering Students Scientific Group ('13-).



**Ph.D. Eng. Roman Szabatin**  
e-mail: R.Szabatin@ire.pw.edu.pl

Roman Szabatin received the M.Sc. degree in electronics apparatus and the Ph.D. degree from Warsaw University of Technology, in 1972 and 1983, respectively. Since 1973, he has been with the Nuclear and Medical Electronics Division, Institute of Radioelectronics, Electronics and Information Technology Faculty, Warsaw University of Technology, as an Associate, Senior Associate, and Senior Scientist. His main research interests include nuclear and medical instrumentation and medical imaging (gamma cameras, SPECT and PET). He has published over 50 scientific papers.



**Ph.D. Eng. Piotr Brzeski**  
e-mail: P.Brzeski@ire.pw.edu.pl

Piotr Brzeski received the M.Sc. degree in electronics apparatus and the Ph.D. degree from Warsaw University of Technology, in 1970 and 1982, respectively. Member of the Faculty Council ('90-); Head of the Dean's Financial Committee ('12-); Member of the Faculty Council Committee on Education ('05-); Director's Representative for Economy and Administration ('12-).



**Ph.D. Eng. Bogumil Konarzewski**  
e-mail: B.Konarzewski@ire.pw.edu.pl

M.Sc. ('91), Ph.D. ('98); nuclear and medical electronics; Assistant Professor, Nuclear and Medical Electronics Division, Institute of Radioelectronics and Multimedia Technology, Faculty of Electronics and Information Technology, Warsaw University of Technology.



otrzymano/received: 20.09.2016

przyjęto do druku/accepted: 15.02.2017